



Built-In-Frame LED Retrofit Kit – Installation Instructions

For 2x2 and 2x4 recessed fluorescent fixtures



WARNING – RISK OF FIRE OR ELECTRIC SHOCK. LUMINAIRE WIRING AND ELECTRICAL PARTS MAY BE DAMAGED WHEN DRILLING FOR INSTALLATION OF LED RETROFIT KIT. CHECK FOR ENCLOSED WIRING AND COMPONENTS

AVERTISSEMENT - RISQUE D'INCENDIE OU DE CHOC ÉLECTRIQUE. CÂBLAGE DU LUMINAIRE ET PIÈCES ÉLECTRIQUES PEUVENT ÊTRE ENDOMMAGÉS LORS DU PERÇAGE POUR L'INSTALLATION DU KIT DE CONVERSION À DEL. VÉRIFIER LE CÂBLAGE ET LES COMPOSANTS CLOS



WARNING – RISK OF FIRE OR ELECTRIC SHOCK. LED RETROFIT KIT INSTALLATION REQUIRES KNOWLEDGE OF LUMINAIRES ELECTRICAL SYSTEMS. IF NOT QUALIFIED, DO NOT ATTEMPT INSTALLATION. CONTACT A QUALIFIED ELECTRICIAN.

ATTENTION - RISQUE DE FEU OU DE CHOC ÉLECTRIQUE. L'INSTALLATION DU KIT DE RÉNOVATION LED NÉCESSITE DES CONNAISSANCES SUR LES SYSTÈMES ÉLECTRIQUES DES LUMINAIRES. SI VOUS N'ÊTES PAS QUALIFIÉS, N'ESSEYEZ PAS DE L'INSTALLER. CONTACTER UN ÉLECTRICIEN QUALIFIÉ.



WARNING – RISK OF FIRE OR ELECTRIC SHOCK. INSTALL THIS KIT ONLY IN LUMINAIRES THAT HAVE THE CONSTRUCTION FEATURES AND DIMENSIONS SHOWN IN THE PHOTOGRAPHS AND/OR DRAWINGS AND WHERE THE INPUT RATING OF THE RETROFIT KIT DOES NOT EXCEED THE INPUT RATING OF THE LUMINAIRE.

ATTENTION - RISQUE DE FEU OU DE CHOC ÉLECTRIQUE. INSTALLER CE KIT UNIQUEMENT DANS LES LUMINAIRES DONT LES CARACTÉRISTIQUES ET LES DIMENSIONS CORRESPONDENT À CELLES INDIQUÉES DANS LES PHOTOS ET SCHÉMAS



WARNING – TO PREVENT WIRING DAMAGE OR ABRASION, DO NOT EXPOSE WIRING TO EDGES OF SHEET METAL OR OTHER SHARP OBJECTS.

ATTENTION - AFIN D'ÉVITER TOUTE ABRASION OU DOMMAGE DU CÂBLAGE ÉLECTRIQUE, NE PAS L'EXPOSER AUX ARRÊTES DES FEUILLES MÉTALLIQUES OU TOUT AUTRE OBJET TRANCHANT



THE RETROFIT KIT IS ACCEPTED AS A COMPONENT OF A LUMINAIRE WHERE THE SUITABILITY OF THE COMBINATION SHALL BE DETERMINED BY CSA OR AUTHORITIES HAVING JURISDICTION



THIS RETROFIT KIT IS SUITABLE FOR IC, ENCLOSED RECESSED LUMINAIRES IN DRY OR DAMP LOCATIONS ONLY



ONLY THOSE HOLES INDICATED IN THE PHOTOGRAPHS AND/OR DRAWINGS MAY BE ALTERED AS A RESULT OF KIT INSTALLATION. DO NOT LEAVE ANY OTHER OPEN HOLES IN AN ENCLOSURE OF WIRING OR ELECTRICAL COMPONENTS.

Parts included in this kit:

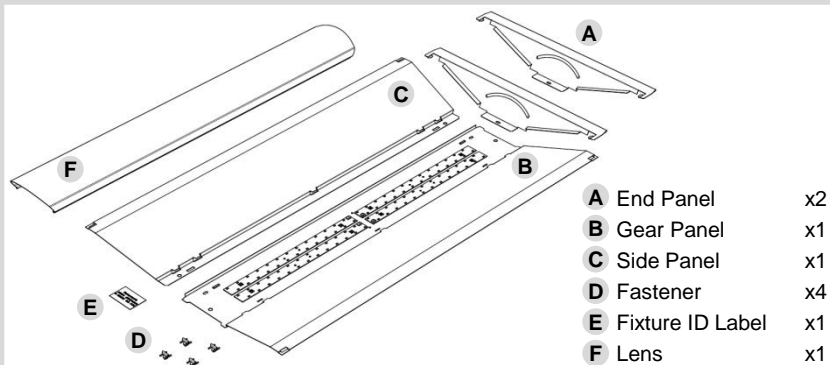

Tools required:



Installer Notes:

- 1) Do not touch LEDs at any point during installation, at risk of damaging them. Use of anti-static or ESD equipment can be used to reduce the risk of damage.
- 2) A set of labels with model, serial number, and date of manufacture are included with the kit and must be adhered within the luminaire during installation. All of these labels must be applied in compliance with UL standards.
- 3) Examine all parts that are not intended to be replaced by the retrofit kit for damage and replace any damaged parts prior to installation of the retrofit kit.
- 4) A pair of earthquake safety cables is included with the kit to be installed if required in your area. Check state and local law and contact Industrial Lighting Products for more information regarding cable installation.
- 5) It is recommended that a single test unit is installed before full renovation to ensure fixture compatibility.

1 Read all Warnings and Installer Notes before proceeding with this retrofit.

2 Check to ensure all parts listed are included in your retrofit kit.

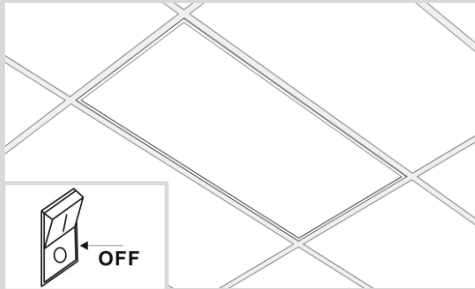

3 Shut off or disconnect power to the fixture.

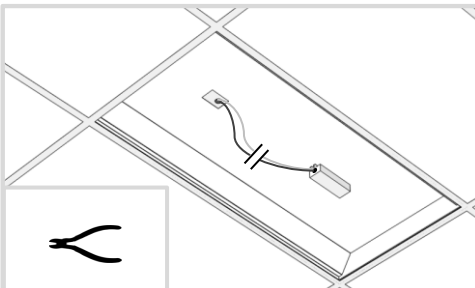
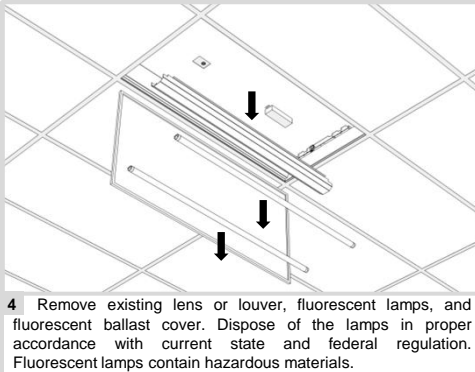

5 Disconnect or sever the wiring from the AC power input to the fluorescent ballast. If space is limited, remove the ballast.

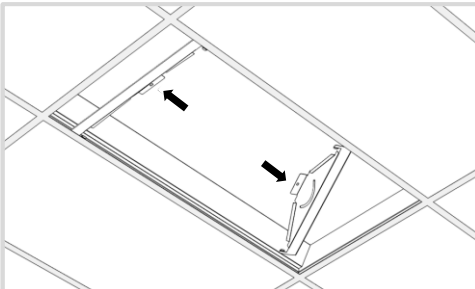

6 Gently lift the original troffer housing and insert the first End Panel between the troffer and the T-grid. Slide the End Panel to one end of the troffer until it cannot move any further. Repeat with the second End Panel.

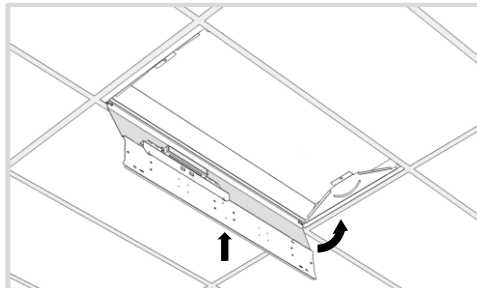

7 Install the Gear Panel by first hooking the slots into the respective tabs in the End Panels. Angle the Gear Panel up into the fixture and slide it in between the troffer and the T-grid, being careful not to bend the End Panel tabs. No gaps should remain where the slots and tabs meet.

- ⚠ DO NOT HANG OR LET GO OF THE GEAR PANEL.
- ⚠ DO NOT TOUCH LEDS, AT RISK OF DAMAGING THEM.

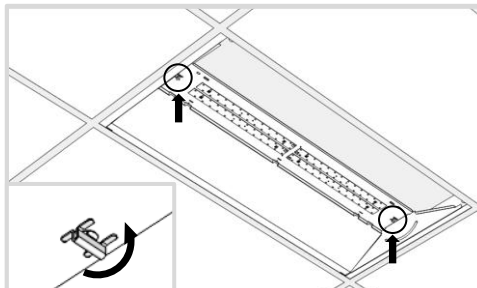

8 Gently push the Gear Panel upward so the holes at either end line up with the slots in the End Panels. Insert one Fastener on either end through both the hole and the slot on each end and rotate 90 degrees to secure the panels.

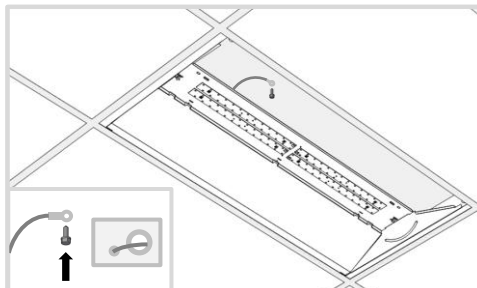

9A If the original fixture ground connection is attached to the fixture housing, use the provided self-drilling screw to attach the BIF ground cable (green) to the fixture housing.

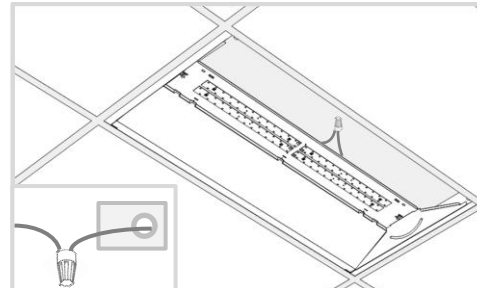

9B If the original fixture ground connection is not attached to the fixture housing, connect it to the BIF ground cable (green) using the proper connectors in accordance with current state and federal regulation.

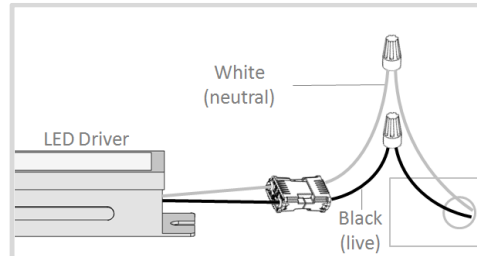

10 Connect AC input cables to the incoming AC power connection using the proper connectors in accordance with current state and federal regulation.

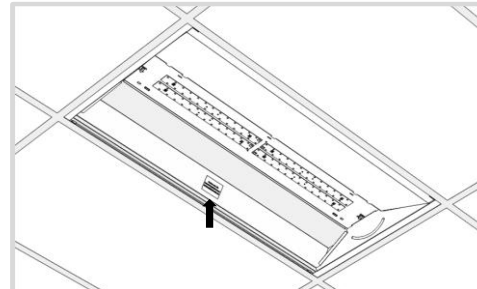

11 Adhere the Fixture ID Label to the original fixture housing in a clearly visible location. This label is required by UL standards.

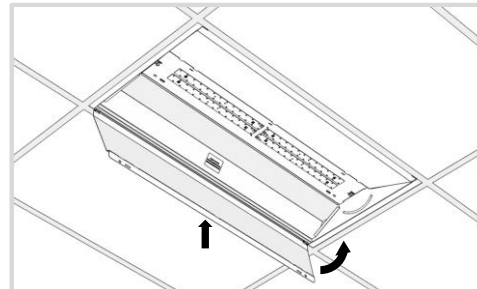

12 Install the Side Panel by first hooking the slots into the respective tabs in the End Panels. Angle the Side Panel up into the fixture and slide it in between the troffer and the T-grid, being careful not to bend the End Panel tabs. No gaps should remain where the slots and tabs meet.

- ⚠ DO NOT HANG OR LET GO OF THE SIDE PANEL

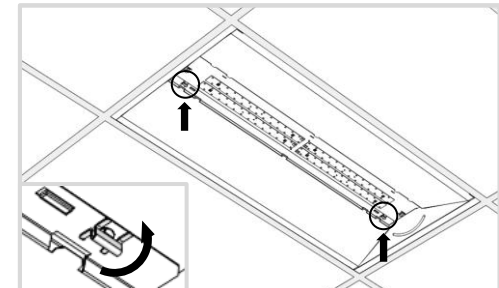

13 Gently push the Side Panel upward so the holes at either end line up with the slots in the End Panels. Ensure that no cables are caught between panels. Insert one Fastener on either end through both the hole and the slot on each end and rotate 90 degrees to secure the panels.

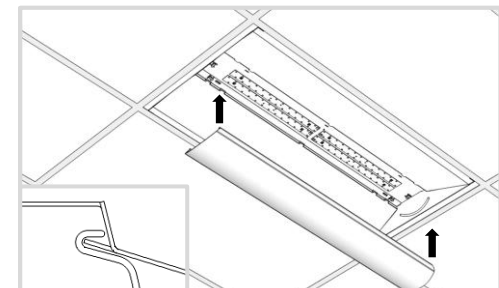

14 Install the Lens by hooking onto the tabs on either the Gear Panel or the Side Panel. Gently compress the Lens to fit it onto the tabs of the opposite panel. Ensure that the Lens is centered and sits evenly within the fixture.

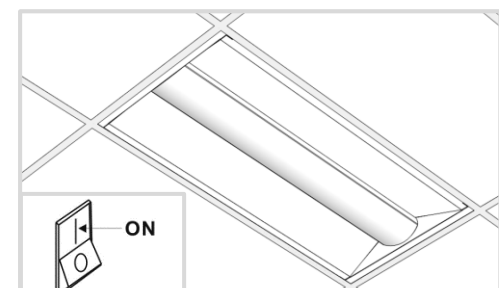

15 Turn on or reconnect power to the fixture to complete the installation.