



SWP LED ADJUSTABLE SLIM WALL PACK

FAO SETTING INSTRUCTIONS

⚠ CAUTION

PLEASE READ INSTRUCTIONS BEFORE COMMENCING INSTALLATION AND RETAIN FOR FUTURE REFERENCE.
Electrical products can cause death or injury, or damage to property. If in any doubt about the installation or use of this product, consult a competent electrician.

⚠ WARNING

To avoid the risk of fire, explosion, or electric shock, this product shall be installed, inspected, and maintained by a qualified electrician, in accordance with all applicable electrical codes.

⚠ WARNING

To avoid electric shock:

- Be certain electrical power is OFF before and during installation or maintenance.
- Luminaire must be connected to a wiring system with equipment-grounding conductor

To avoid explosion:

- Make sure the supply voltage is the same as the rated luminaire voltage.
- Do not install where marked operating temperatures exceed the ignition temperature of the hazardous atmosphere.
- Do not operate in ambient temperatures above those indicated on the luminaire.

Introduction:

1. If FAO does not need to be adjusted (default setting is maximum output), install luminaire as normal.
2. Read all Warnings and Installer Notes before proceeding with this installation.

Power comes into the luminaire and connects into the driver. The FAO module is connected to the driver via 0-10V dimming.

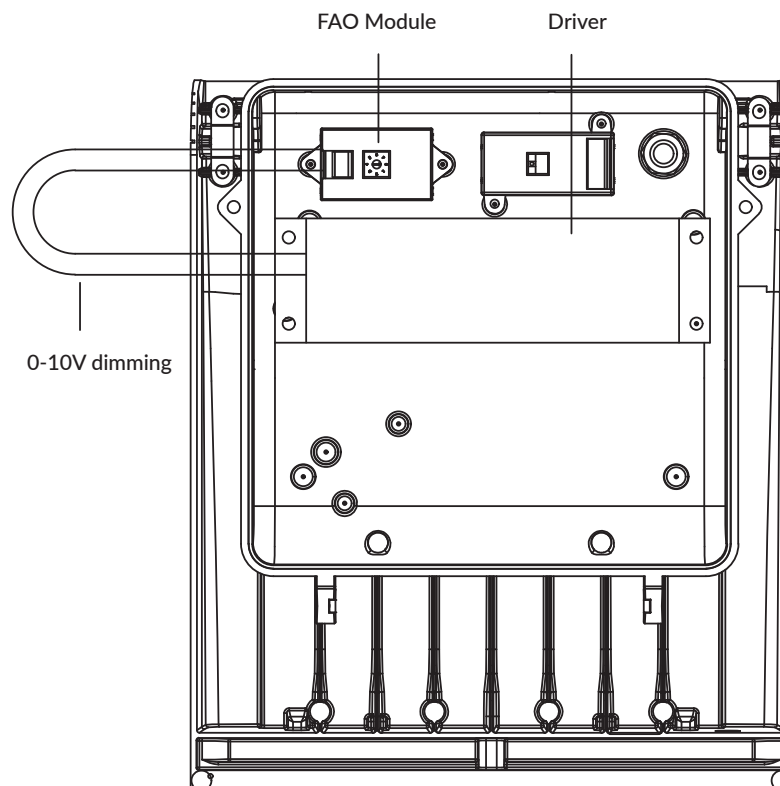



SWP LED ADJUSTABLE SLIM WALL PACK

FAO SETTING INSTRUCTIONS

Introduction :

- The field-adjustable output (FAO) is an on-board device that adjusts the light output and input wattage to meet site-specific requirements, allowing a single luminaire configuration to be individually dimmed to the needs of that location.
- The FAO device adjusts the light output and input wattage to meet site-specific requirements, allowing the user to define specific luminaire-by-luminaire settings.
- A dimming level set is adjusted through a rotary switch located on the front of the module. The rotary switch has a screwdriver slot for a dimming level selection, and a detent feature for each set level (0 to 7)

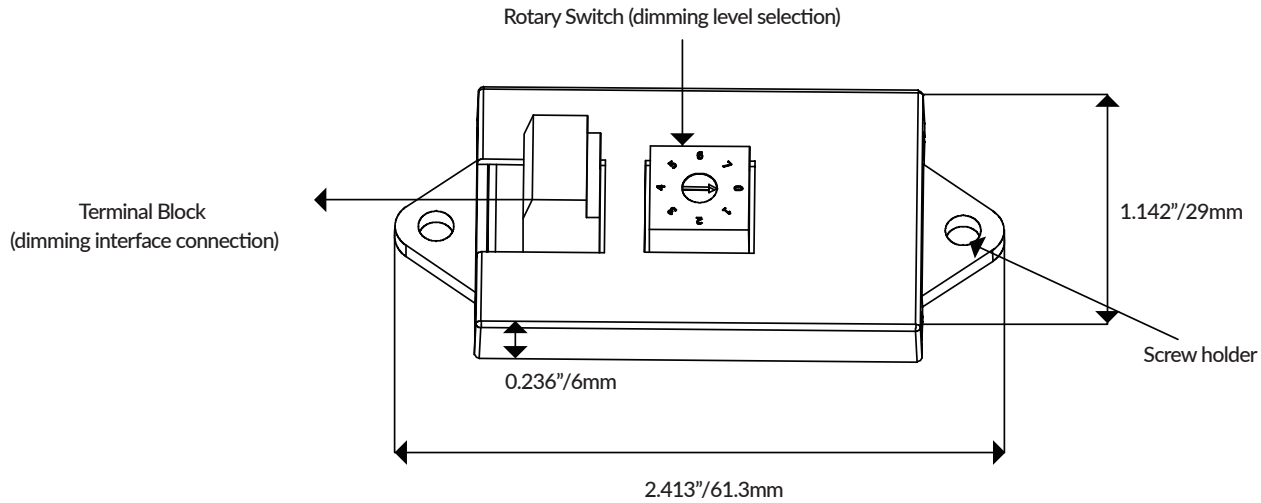

Installation Steps - Quick Install

1. Use a 3/32 hexagon wrench to loose the side hex screws and adjust luminaire head upward to 90 degrees, and open the driver box by unscrewing the top part of the driver box. (Figure 1).
2. In all SWP family luminaires, the FAO module is in the approximate location shown in (Figure 2a). Use a flat-head screwdriver to turn the FAO dial (Figure 2b). Note that position 0 is the default setting and the maximum output value (no dimming). For Contractor Select configurations, refer (Table 1) on the next sheet for lumen output values.
3. Make sure that wires and door tethers are not pinched and that the door gasket is still snugly in its groove on the door. Close and secure the driver box, by screwing back the driver box screws.

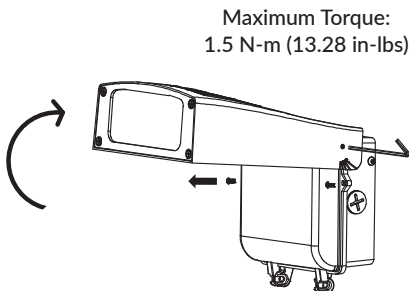

Figure 1

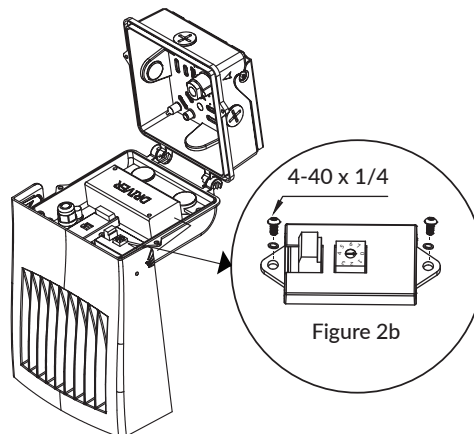

Figure 2a

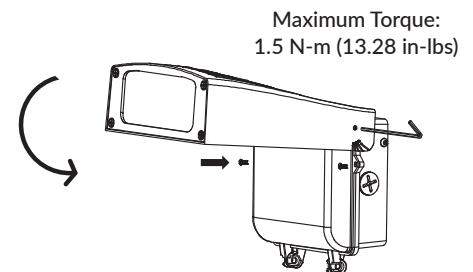

Figure 3



SWP LED ADJUSTABLE SLIM WALL PACK

FAO SETTING INSTRUCTIONS

SWP-2L-U-CCTS-BRZ	FAO Position	0	1	2	3	4	5	6	7
	Input Power (w)	20	17	14	12	9	7	4	2
	* Approx Lumens @3000K	2400	2112	1800	1776	1224	912	528	168
	* Approx Lumens @4000K	2700	2376	2025	1998	1377	1026	594	189
	* Approx Lumens @5000K	2500	2200	1875	1850	1275	950	550	175
SWP-3L-U-CCTS-BRZ	FAO Position	0	1	2	3	4	5	6	7
	Input Power (w)	24	20	17	14	11	8	5	2
	* Approx Lumens @3000K	3240	2786	2398	1976	1523	1069	616	107
	* Approx Lumens @4000K	3480	2993	2575	2123	1636	1148	661	115
	* Approx Lumens @5000K	3360	2890	2486	2050	1579	1109	638	111
SWP-5L-U-CCTS-BRZ	FAO Position	0	1	2	3	4	5	6	7
	Input Power (w)	40	33	28	24	19	14	8	3
	* Approx Lumens @3000K	5400	4644	3996	3456	2754	1998	1080	351
	* Approx Lumens @4000K	5800	4988	4292	3712	2958	2146	1160	377
	* Approx Lumens @5000K	5600	4816	4144	3584	2856	2072	1120	364
SWP-8L-U-CCTS-BRZ	FAO Position	0	1	2	3	4	5	6	7
	Input Power (w)	65	57	48	40	33	23	14	6
	* Approx Lumens @3000K	8100	7209	6318	5427	4374	3159	1863	648
	* Approx Lumens @4000K	8700	7743	6786	5829	4698	3393	2001	696
	* Approx Lumens @5000K	8400	7476	6552	5628	4536	3276	1932	672
SWP-10L-U-CCTS-BRZ	FAO Position	0	1	2	3	4	5	6	7
	Input Power (w)	80	74	63	52	40	29	18	7
	* Approx Lumens @3000K	10000	9500	8000	6900	5400	4000	2300	850
	* Approx Lumens @4000K	10875	10331	8700	7504	5873	4350	2501	924
	* Approx Lumens @5000K	10500	9975	8400	7245	5670	4200	2415	893

*FAO device shipped set at maximum setting #0

Values are based on the highest performance package for each fixture size.